

22 August 2013

Recap: Decoder examples

Arithmetic Logic Unit (ALU)

Parity

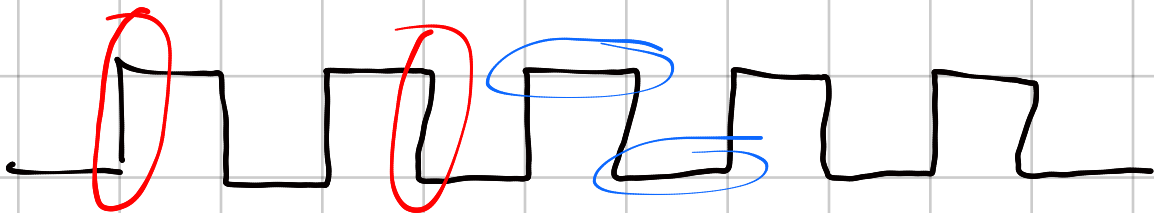

Edge triggered

level triggered.

holds memory.

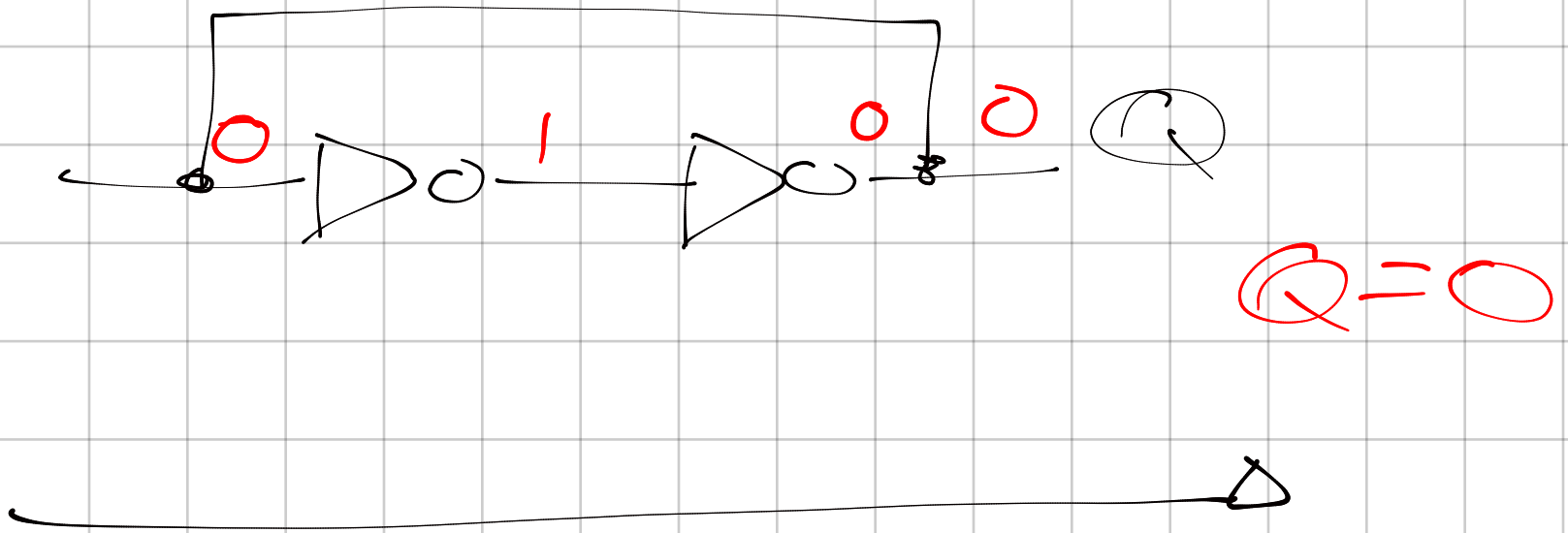

# S-R latch

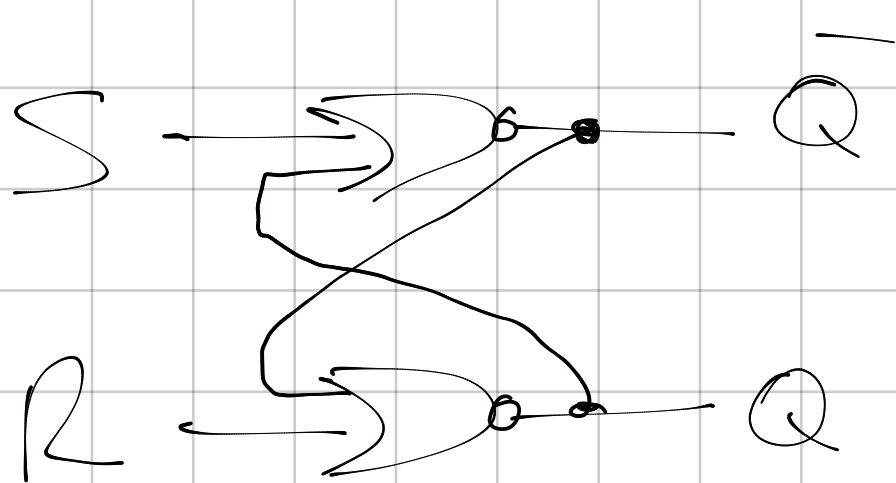

S	R	Q.
0	0	hold.
1	0	1
0	1	0
1	1	Undefined

NB → NOR GATES

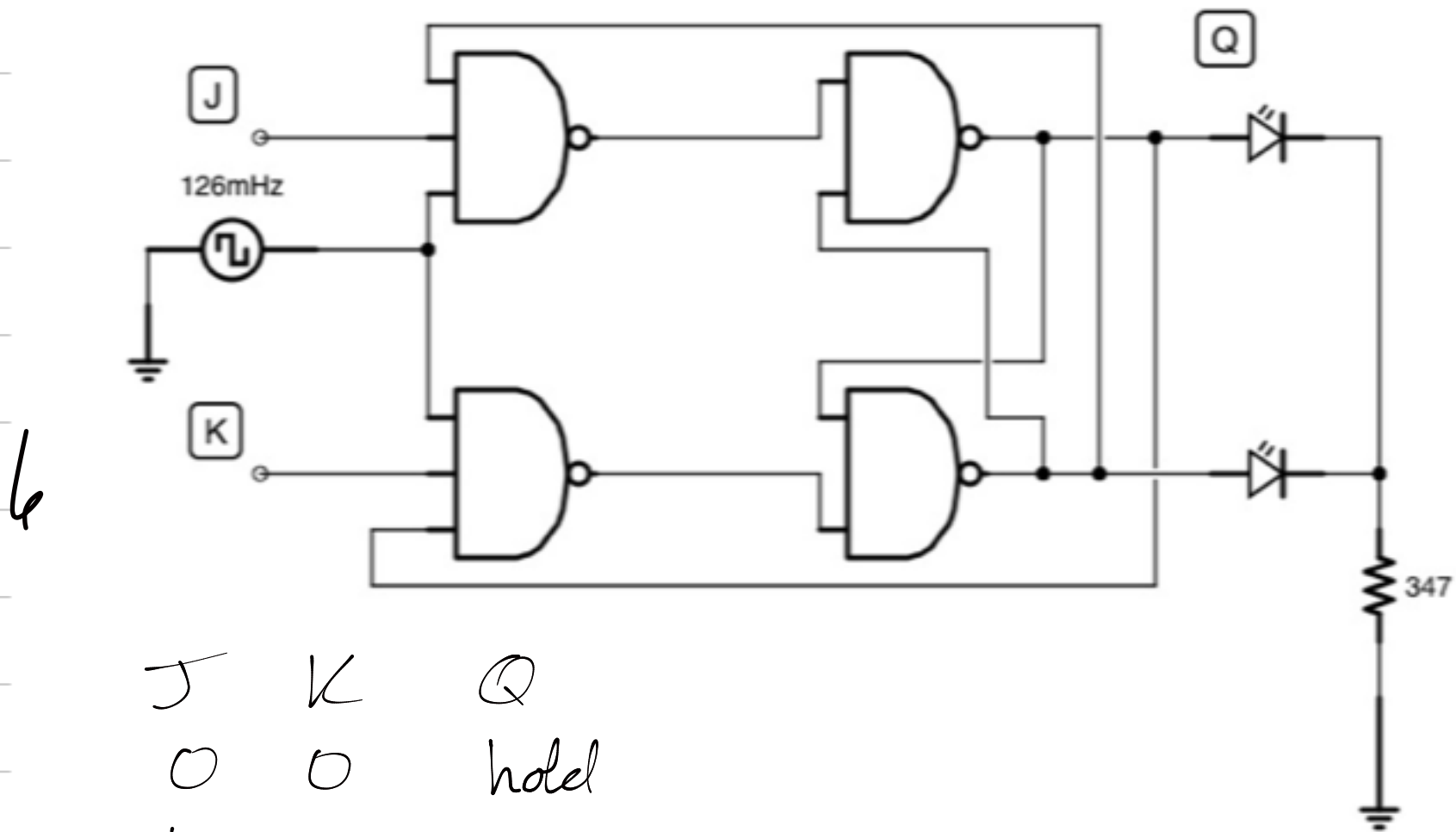

J	K	Q
0	0	hold
1	0	1
0	1	0
1	1	Toggle

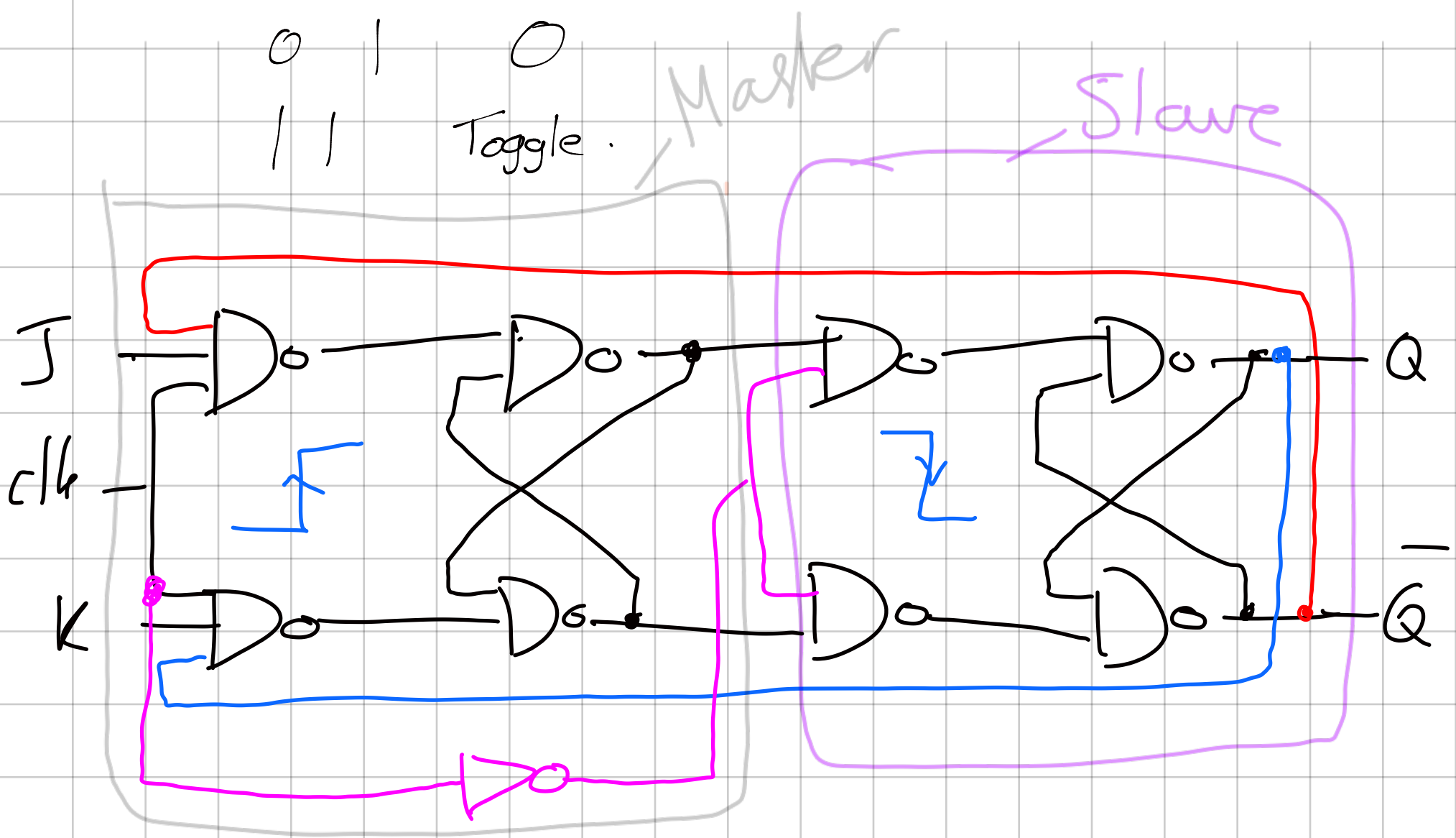

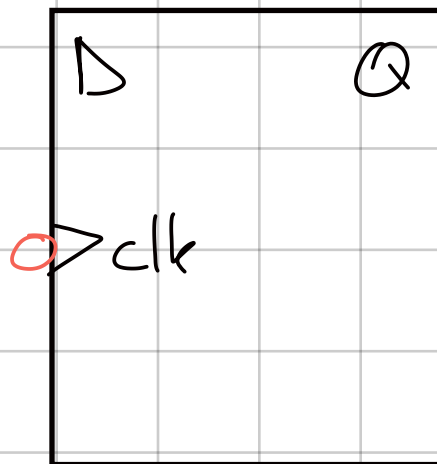
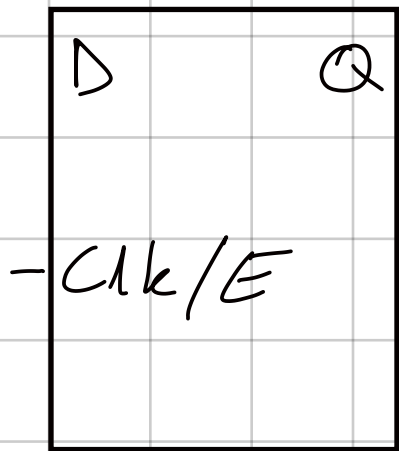
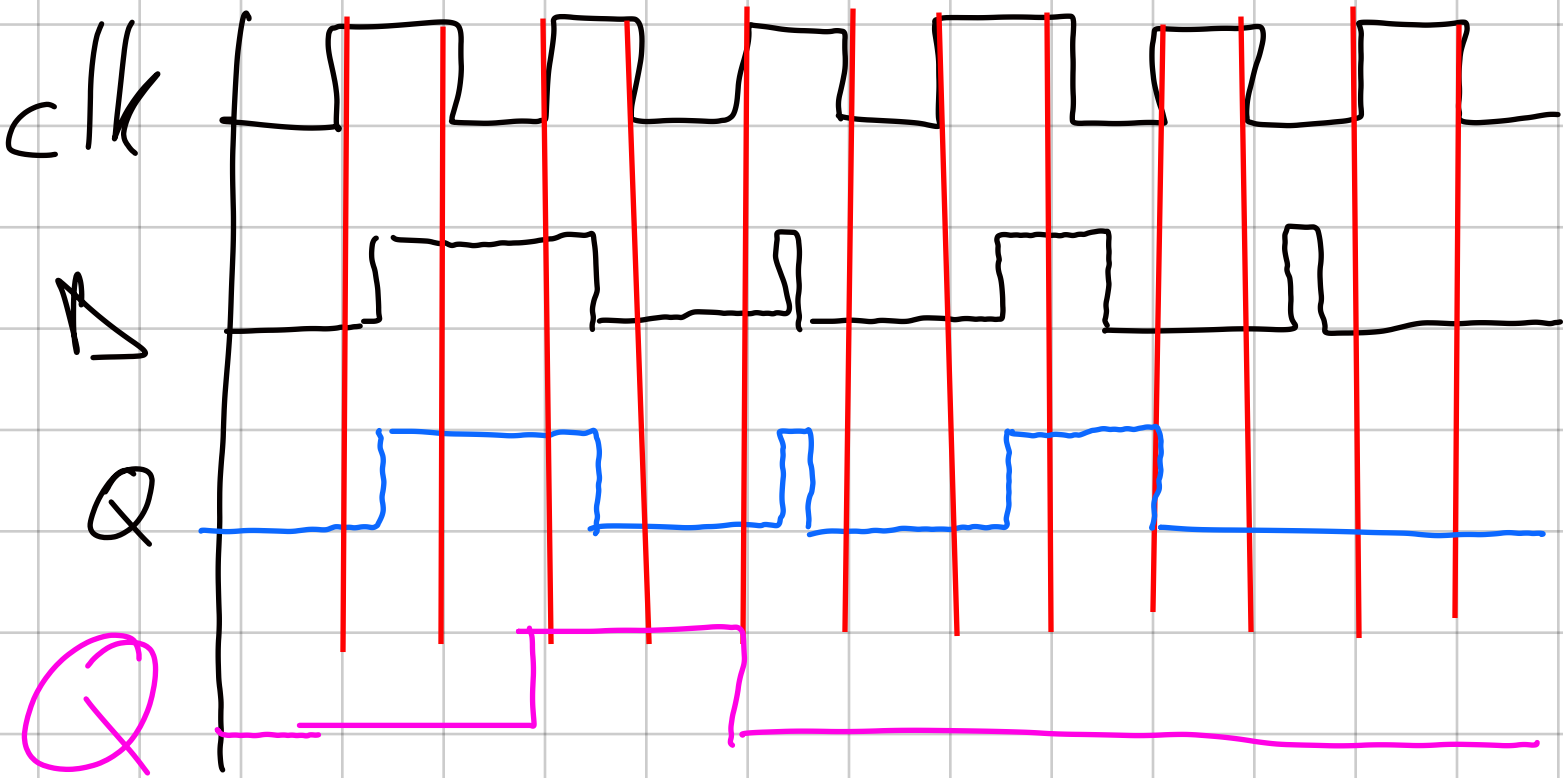
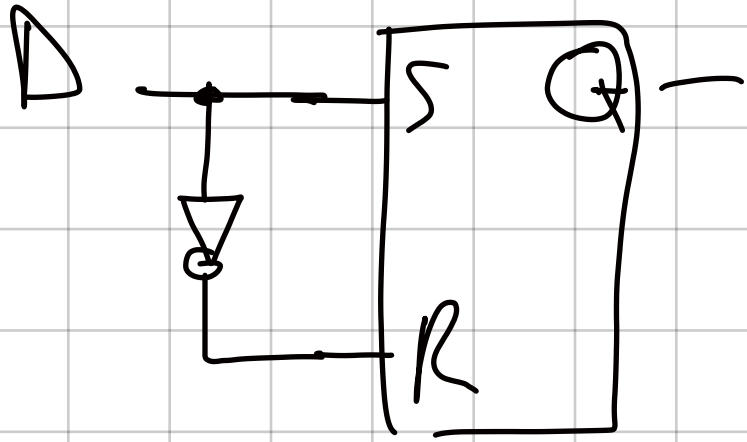
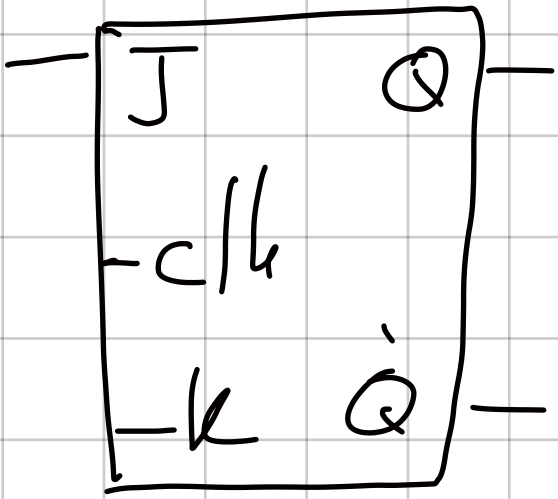

Counter

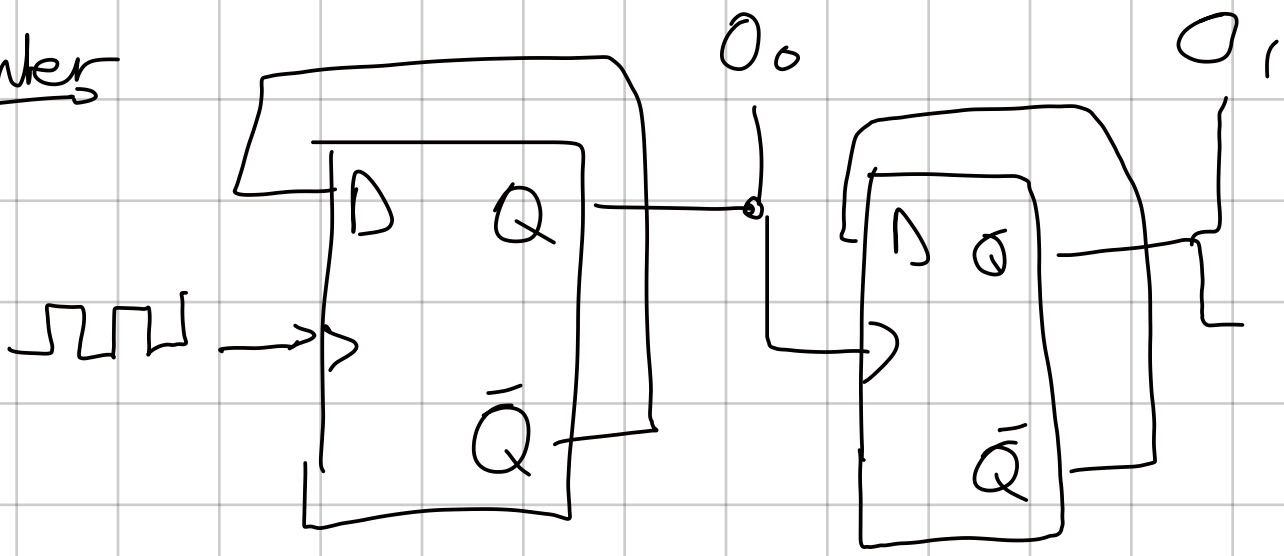

0 1 0 0